

Acontrol

PKE-6 /-10 / PKE-14

P-controller and speed controller for variable voltage 1 ~ fans

Operating Instructions



Content

| | | |
|----------|--|-----------|
| 1 | General notes | 3 |
| 1.1 | Structure of the operating instructions | 3 |
| 1.2 | Target group | 3 |
| 1.3 | Exclusion of liability | 3 |
| 1.4 | Copyright | 3 |
| 2 | Safety information | 3 |
| 2.1 | Use as intended | 3 |
| 2.2 | Explanations of symbols | 4 |
| 2.3 | Product safety | 4 |
| 2.4 | Requirements placed on the personnel / due diligence | 4 |
| 2.5 | Start-up and during operation | 4 |
| 2.6 | Work on the device | 5 |
| 2.7 | Modifications / interventions in the device | 5 |
| 2.8 | Operator's obligation of diligence | 5 |
| 2.9 | Employment of external personnel | 5 |
| 3 | Product overview | 6 |
| 3.1 | Operational area | 6 |
| 3.2 | Maintenance | 6 |
| 3.3 | Transport | 6 |
| 3.4 | Storage | 6 |
| 3.5 | Waste disposal / recycling | 6 |
| 4 | Mounting | 6 |
| 4.1 | General notes | 6 |
| 4.2 | Minimum space requirement | 7 |
| 4.3 | Outdoor installation | 7 |
| 4.4 | Installation location for agriculture | 7 |
| 4.5 | Temperature influences during commissioning | 7 |
| 5 | Electrical installation | 8 |
| 5.1 | Safety precautions | 8 |
| 5.2 | EMC-compatible installation | 8 |
| 5.2.1 | Motor feeder cable | 8 |
| 5.2.2 | Signal cable | 8 |
| 5.3 | Mains connection | 8 |
| 5.4 | Motor connection | 9 |
| 5.4.1 | Running noise | 9 |
| 5.5 | Motor protection | 9 |
| 5.6 | Signal or sensor connection (E1 = Analog In 1) | 9 |
| 5.7 | Output voltage 10 - 10 V (A = Analog Out) | 9 |
| 5.8 | Voltage supply for external devices (+24V, GND) | 10 |
| 5.9 | Enable, device ON / OFF (Digital In 1 = D1) | 10 |
| 5.10 | Potential at control voltage connections | 10 |
| 6 | Operating and display elements | 11 |
| 7 | Base setup | 12 |
| 7.1 | Programming of the desired function (Speed controller / P-Controller) | 12 |
| 7.2 | Select operation mode | 12 |
| 7.3 | Function of dipswitches for operation as Speed controller 1.01 (DIP <input type="checkbox"/> = <input type="checkbox"/> OFF) | 13 |
| 7.4 | Function of dipswitches for operation as P-Controller 2.01 , 3.01 , (DIP <input type="checkbox"/> = <input type="checkbox"/> ON) | 13 |
| 7.5 | Minimum speed cut off DIP 2 | 13 |

| | | |
|-----------|--|-----------|
| 7.5.1 | For mode Speed controller 1.01 | 13 |
| 7.5.2 | For operation as P-Controller 2.01, 3.01 | 14 |
| 8 | Start-up | 14 |
| 8.1 | Prerequisites for commissioning | 14 |
| 9 | Setting for operation | 15 |
| 9.1 | Speed controller 1.01 | 15 |
| 9.1.1 | Setting for operation as Speed controller | 15 |
| 9.1.2 | Diagram: setting signal and speed | 15 |
| 9.1.3 | Operation with two variable output voltages (two steps) | 16 |
| 9.2 | Temperature control (P-Controller) 2.01 | 16 |
| 9.2.1 | Setting for operation as Temperature controller | 16 |
| 9.2.2 | Example Temperature control "Cooling function" (factory setting) | 17 |
| 9.2.3 | Example Temperature control "Heating function" | 17 |
| 9.3 | Pressure control condensers (P-Controller) 3.01 | 18 |
| 9.3.1 | Setting for operation as Pressure controller | 18 |
| 9.3.2 | Example Pressure control condensers | 18 |
| 9.3.3 | Setting with refrigerant medium table | 19 |
| 10 | Diagnostics / Faults | 20 |
| 10.1 | If controller doesn't work correctly | 20 |
| 11 | Enclosure | 21 |
| 11.1 | Technical data | 21 |
| 11.1.1 | Performance reduction during elevated ambient temperatures | 21 |
| 11.2 | Connection diagram | 22 |
| 11.2.1 | Connection diagram motor protection unit for motors with thermostats type S-ET10 | 23 |
| 11.3 | Dimensions [mm] | 24 |
| 11.4 | Index | 25 |
| 11.5 | Manufacturer reference | 26 |
| 11.6 | Service information | 26 |

1 General notes

1.1 Structure of the operating instructions

**Before installation and start-up, read this manual carefully to ensure correct use!
We emphasize that these operating instructions apply to specific units only, and are in no way valid for the complete system!**

Use these operating instructions to work safely with and on the device. They contain safety instructions that must be complied with as well as information that is required for failure-free operation of the device.

Keep these operating instructions together with the device. It must be ensured that all persons that are to work on the device can refer to the operating instructions at any time.

Keep the operating instructions for continued use. They must be passed-on to all successive owners, users and final customers.

1.2 Target group

The operating instructions address persons entrusted with planning, installation, commissioning and maintenance and servicing and who have the corresponding qualifications and skills for their job.

1.3 Exclusion of liability

Concurrence between the contents of these operating instructions and the described hardware and software in the device has been examined. It is still possible that non-compliances exist; no guarantee is assumed for complete conformity. To allow for future developments, construction methods and technical data given are subject to alteration. We do not accept any liability for possible errors or omissions in the information contained in data, illustrations or drawings provided.

Ziehl-Abegg AG is not liable for damage due to misuse, incorrect use, improper use or as a consequence of unauthorized repairs or modifications.

1.4 Copyright

These operating instructions contain copyright protected information. The operating instructions may be neither completely nor partially photocopied, reproduced, translated or put on data medium without previous explicit consent from Ziehl-Abegg AG. Infringements are liable for damages. All rights reserved, including those that arise through patent issue or registration on a utility model.

2 Safety information

This chapter contains instructions to prevent personal injury and property damage. These instructions do not lay claim to completeness. In case of questions and problems, please consult our company technicians.



2.1 Use as intended

The equipment is to be used solely for the purposes specified and confirmed in the order. Other uses which do not coincide with, or which exceed those specified will be deemed unauthorised unless contractually agreed. Damages resulting from such unauthorised uses will not be the liability of the manufacturer. The user will assume sole liability.

Reading these operating instructions and complying with all contained instructions – especially the safety notifications contained therein – are considered part of intended use. To consider is also the manual of attached components. Not the manufacturer, rather the operator of the device is liable for any personal harm or material damage arising from non-intended use!

2.2 Explanations of symbols

Safety instructions are highlighted with warning triangles and are depicted according to the degree of hazard as follows.

| | |
|---|--|
|  | Attention! Hazardous area. Death or severe injury or significant property damage can occur if the corresponding precautions are not taken! |
|  | Danger owing to electric current Danger owing to electric current or voltage. |
|  | Information Important information and advice for user. |

2.3 Product safety

The device conforms to the state of the art at the time of delivery and is fundamentally considered to be reliable. The device and its accessories must only be used in a flawless condition and installed and operated in compliance with the assembly instructions and/or operating instructions. Operating outside the device's technical specifications (☞ rating plate and attachment / technical data) can lead to a defect in the device and additional damage!

In the case of a malfunction or a failure of the equipment check all functions with alarms in order to prevent injury to persons or property. Note possibility of back-up operation. If used in intensive animal environments, any malfunctions in the air supply must be detected as soon as possible to prevent the development of a life-threatening situation for the animals. The design and installation of the system must comply with local regulations and directives. In Germany these include DIN VDE 0100, the animal protection and the keeping of working animals ordinance and the pig-keeping ordinance etc. Also note the instructions of AEL, DLG, VdS.

2.4 Requirements placed on the personnel / due diligence

Persons entrusted with the planning, installation, commissioning and maintenance and servicing in connection with the frequency inverter must have the corresponding qualifications and skills for these jobs.

In addition, they must be knowledgeable about the safety regulations, EU directives, rules for the prevention of accidents and the corresponding national as well as regional and in-house regulations. Personnel to be trained or instructed and apprentices are only permitted to work on the device under the supervision of an experienced person. This also applies to personnel undergoing general training. Comply with the legal minimum age.

2.5 Start-up and during operation



Attention!

During commissioning, unexpected and hazardous conditions can arise in the entire installation due to defective adjustments, defective components or incorrect electrical connections. Remove all persons and objects from the hazardous area.

During operation, the device must be closed or installed in a control cabinet. Fuses may only be replaced by new ones and must not be repaired or bypassed. The data for the maximum line fuse are to be considered absolutely (☞ Technical data). Use only fuses specified in schematic diagrams. Any faults detected in the electric system/modules/operating equipment must be corrected immediately. If these faults are not corrected, the device/system is potentially very dangerous. The device/system must therefore not be operated when it is faulty.

2.6 Work on the device



Information

Installation, electrical connection, and start-up operation may only be carried out by an electrical specialist in accordance with electrotechnical regulations (e.g. DIN EN 50110 or DIN EN 60204).



Danger owing to electric current

It is forbidden to carry out work on electrically live parts. The enclosure rating of the device when open is IP 00! It is possible to inadvertently touch components carrying hazardous voltages!

The safe isolation from the supply must be checked using a **two-pole** voltage detector.



Attention!

Automatically restart after a power failure or mains disconnection!

2.7 Modifications / interventions in the device



Attention!

For reasons of safety, no unauthorized interventions or modifications may be made on the device. All planned modifications must be authorized by the manufacturer in writing.

Use only genuine spare parts / genuine wearing parts / genuine accessories from Ziehl-Abegg. These parts were specifically designed for the device. There is no guarantee that parts from non-original sources are designed and manufactured in correspondence with load and safety requirements. Parts and optional equipment not supplied by Ziehl-Abegg are not approved by Ziehl-Abegg for use.

2.8 Operator's obligation of diligence

- The contractor or owner must also ensure that the electric systems and equipment are operated and maintained in accordance with electro-technical regulations.
- The owner is obliged to ensure that the device are operated in perfect working order only.
- The device may only be used as intended (☞ "Application").
- You must periodically examine the safety equipment for their properly functioning condition.
- The assembly instructions and/or operating instructions are always readily available at the location where the device is being used, are complete and are in legible condition.
- These persons are regularly instructed in all applicable questions regarding occupational safety and environmental protection and are knowledgeable regarding the assembly instructions and/or operating instructions and, especially, are familiar with the safety instructions contained therein.
- All safety and warning notices attached to the frequency inverter are never removed and remain legible.

2.9 Employment of external personnel

Maintenance and service work are frequently carried out by external employees who often do not recognize the specific situations and the thus resulting dangers. These persons must be comprehensively informed about the hazards in their area of activity.

You must monitor their working methods in order to intervene in good time if necessary.

3 Product overview

3.1 Operational area

The controller described is used for continuous speed adjustment on variable voltage 1~ motors used to drive ventilators or pumps.

3.2 Maintenance

The device must be checked for soiling and, if necessary, cleaned in periodic intervals.

3.3 Transport

- The device is packed ex works to suit the transport method previously agreed.
- Always use the original packaging materials when transporting the device.
- Avoid shocks and impacts to the device during the transport.
- During manual handling the human lifting and carrying restrictions must be observed and adhered to.

3.4 Storage

- The device must be stored in its original packaging in a dry and weather-proof room.
- Avoid exposure to extreme heat and cold.
- Avoid over-long storage periods (we recommend a maximum of one year).

3.5 Waste disposal / recycling

Disposal must be carried out professionally and environmentally friendly in accordance with the legal stipulations.

4 Mounting

4.1 General notes



Attention!

The following points must be complied with during the mechanical installation to avoid causing a defect in the device due to assembly errors or environmental influences:

- Before installation remove the device from the packing and check for any possible shipping damage!
- Assemble the device on a clean and stable base. Do not distort during assembly! Use the appropriate mounting devices for proper installation of the unit!
- Do not mount equipment on vibrating base!
- When mounted onto lightweight walls, there must be no impermissibly high vibrations or shock loads. Any banging shut of doors that are integrated into these lightweight walls, can result in extremely high shock loads. Therefore, we advise you to decouple the devices from the wall.
- Do not allow drilling chips, screws and other foreign bodies to reach the device interior!
- The plastic washers must be installed between the screw heads and the housing for models with mounting holes on the inside of the housing!
- The device should be installed in a location where it will not be disturbed, but at the same time can be easily accessed!
- Depending on the housing model use supplied stoppers for cable inlets, cut off necessary cable inlets respectively to the cable diameter. Or alternative use cable inlet for cable glands. Any cable ducts openings not used must be sealed!
- Care must be taken to avoid direct radiation from the sun!
- The device is designed for vertical installation (cable inlet down). A horizontal or reclined installation is only permissible after technical release of the manufacturer!
- Be sure to observe proper heat dissipation (☞ Technical data, heat dissipation).

4.2 Minimum space requirement

In order to ensure sufficient ventilation of the device, clearance on all sides of at least 50 mm has to be maintained to the housing walls, switch cabinet doors, wiring ducts, etc. The same clearance applies to the installation of several devices next to each other.

When installing several devices on top of each other, the danger of reciprocal heating exists. This layout is only then permissible when the air suctioned from the upper unit does not become warmer than the permissible ambient temperature (☞ Technical data). I.e., a correspondingly larger clearance or thermal shielding is required.

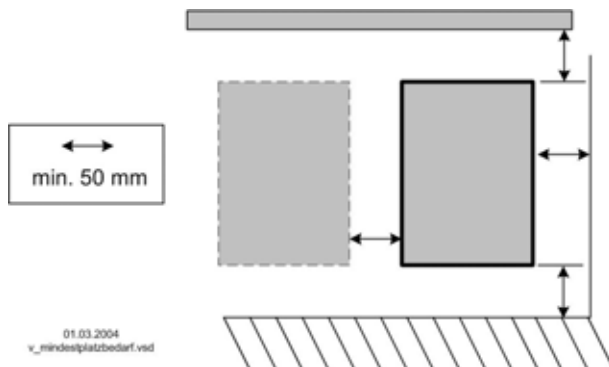

4.3 Outdoor installation

Outdoor installation is possible up to -20 °C when the controller supply is not switched off. Installation must be protected from the effects of weather as much as possible, including protection from direct sunlight!

4.4 Installation location for agriculture

In order to avoid damage caused by ammoniac vapours, the controller shall not be installed in the stable, but rather in an outhouse wherever possible.

4.5 Temperature influences during commissioning

Avoid condensation in the controller and hence functional faults attributable to condensation by storing the controller at room temperature!

5 Electrical installation

5.1 Safety precautions



Danger owing to electric current

- Work on electric components may only be carried out by trained electricians or by persons instructed in electricity under the supervision of an electrician in accordance with electrical engineering regulations.
- It is forbidden to carry out work on electrically live parts.
- A second person must always be present when working on energized parts or lines who disconnects in case of emergency.
- Inspect electrical equipment periodically: retighten loose connections – immediately replace damaged lines and cables.
- Always keep switch cabinets and all electrical supply facilities locked. Access is only allowed for authorized persons using a key or special tool.
- Operating the device with the housing cover removed is prohibited because energized, exposed parts are present inside the device. Disregarding this regulation can lead to severe personal injury.
- The required protective earth connection is established using screws between the housing parts in metal terminal space covers and housing casings. Commissioning is only permissible after these screws have been properly attached!
- Metal screwed-connections are not permitted in plastic housing parts because there is no potential equalization.
- Never clean electrical equipment with water or similar liquids.



Information

The respective connections are represented in the enclosure of this manual (☞ Connection diagram)!

5.2 EMC-compatible installation

5.2.1 Motor feeder cable

The applicable standard for interference emissions is EN 61000-6-3. Compliance with this standard is achieved through the use of an unscreened motor feed cable.

5.2.2 Signal cable

Pay attention to sufficient distance from powerlines and motor wires to prevent interferences. The control cable may not be longer than 30 m. Screened control cables must be used when the cable length is longer than 20 m. When using a shielded cable connect the shielding to one side only, i.e. only to the control unit with the protective ground (keep cable short and with as little inductance as possible!).

5.3 Mains connection

Power from the mains is connected to terminals: PE, L1 and N. Here, it must be strictly observed that the mains voltage lies within the allowable tolerance specifications (☞ Technical data and nameplate affixed to the side).



Danger owing to electric current

The mains voltage must comply with the DIN EN 50160 quality characteristics and the defined standard voltages in IEC 60038!

5.4 Motor connection

The motor is connected at terminals U1 and U2. Several motors can be connected to the device.



Attention

The maximum total control current (specified for electronic voltage regulation) for all motors may not exceed the device's rated current.

If the maximum control current for electronic voltage regulation is not known, a supplementary 20 % of the rated motor current must be allowed for.

When controlling motors from other manufacturers, the controllability and the maximum current for electronic voltage regulation should be requested from the manufacturer.



Information

- It is recommended that a separate motor protection unit be foreseen for each fan.
- For motors with thermistors "TB" e.g. type S-ET10.

5.4.1 Running noise

When controlling ventilators using electronic voltage regulators, motor noise can occur (due to the system), which can be troublesome (Phase cutting = series "P...").

On fast running ventilators with a high level of air noise, this noise is relatively low. On slow running ventilators with a low level of air noise, this noise may be dominant in the lower speed range due to the occurrence of resonance.

For systems where noise is critical, we recommend using our controllers series **STEPcontrol**, **SINUcontrol** or **Fcontrol**

5.5 Motor protection



Attention!

Motor thermostats cannot be connected to these controller. I.e. a separate motor protection is required. We cannot under any circumstances accept liability for damage to the motors which do not have the required motor protection. It is recommended that every fan is equipped with a separate motor protection unit e.g. type S-ET10 (☞ connection diagram) !

5.6 Signal or sensor connection (E1 = Analog In 1)

The unit has one-analog input: terminals "E1" / "GND" (Analog In 1).

The connection is independent of the programmed operating mode and from the sensor signal employed.

The internal jumpers must be placed in correct position depending on input signal. Factory setting 0 - 10 V.

- When connecting **passive** temperature sensors TF.. (KTY81-210) must be paid attention to no polarity.
- When connecting **active** sensors attention must be paid to correct polarity, a 24 V DC power supply is integrated.
- For sensors in two-wire-technology (4 - 20 mA signal), the connection is made on the "+24 V" and "E1" ("GND" terminal is omitted).

Over DIP 4 an inverting of the input is possible for mode **1.01 speed controller.**

- DIP 4 = OFF (factory setting) for signals: 0 - 10 V, 2 - 10 V, 0 - 20 mA, 4 - 20 mA
- DIP 4 = ON for signals: 10 - 0 V, 10 - 2 V, 20 - 0 mA, 20 - 4 mA



Attention!

Never apply line voltage to analog inputs!

5.7 Output voltage 10 - 10 V (A = Analog Out)

Constant voltage +10 V e. g. for external potentiometer by operation as speed controller **1.01**.

Connection to terminals "A1" - "GND" = "Analog Out 1" (I_{max} 10 mA).

It is not permissible to connect outputs of several devices to each other!

5.8 Voltage supply for external devices (+24V, GND)

There is an integrated power supply for external devices, e.g. a sensor. Terminal +24 V, output voltage tolerance +/- 20%. max. load current ☞ Technical data.

It is not permissible to connect outputs of several devices to each other!

In case of overload or short circuit (24 V – GND), the external power supply is shut down (multi-fuse). The device performs a “Reset” and continues operation.

5.9 Enable, device ON / OFF (Digital In 1 = D1)

Electronic disconnection via floating contact at terminals “D1” - “GND”

- Device “ON” for closed contact.
- Controller “OFF” with opened contact. Internal signal lamp flashes in code **1** (☞ (Diagnostics / Faults).

Activation via floating contacts, a low voltage of approx. 24 V DC is connected.



Attention!

No disconnection (isolation) when turned off, in accordance with VBG4 §6!

Never apply line voltage to the digital input!

It is not permissible to connect inputs of several devices to each other!

5.10 Potential at control voltage connections

The control voltage connections (< 50 V) relate to the joint GND potential (Exception: Relay contacts are potential free). There is a potential separation between the control voltage connections and the earthed conductor. It must be ensured that the maximum external voltage at the control voltage connections cannot exceed 50V (between “GND” terminals and “PE” earthed conductor). If necessary, a connection to the earthed conductor potential can be established, install bridge between “GND” terminal and the “PE” connection (terminal for screening).

6 Operating and display elements

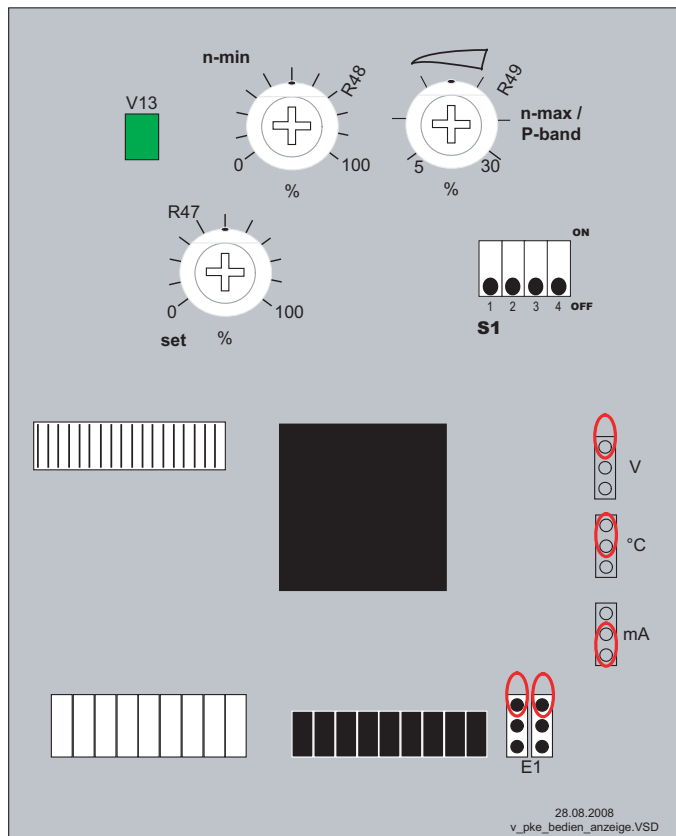

| | |
|---------------------------------------|---|
| Potentiometer set | <p>Function dependently on selected mode of operation</p> <ul style="list-style-type: none"> • For Speed controller 1.01 without function. • For temperature control 2.01 with passive sensors TF.. (KTY). setting range: 0 - 100 % \pm -26...76 °C (measuring range of controller). • For control with active sensors 3.01, (0 - 10 V, 4 - 20 mA). Setting range: 0 - 100 % \pm measuring range of sensor. |
| Potentiometer n-min | <p>Minimal output voltage (basic speed) Setting range: 0 - 100 % ("n-min" takes priority if over "n-max")</p> |
| Potentiometer n-max / Pband | <p>Function dependently on selected mode of operation</p> <ul style="list-style-type: none"> • For speed controller 1.01 Maximal output voltage speed limiter: <ul style="list-style-type: none"> – Setting range: 100 % - "n-min" (100 % output voltage = fully clockwise position 30 %) • For P-Controller, 2.01, 3.01 Pband (control range) <ul style="list-style-type: none"> – For temperature control with passive sensors TF.. (KTY). Setting range: 5 - 30 % \pm 5.1 - 30.6 K. – For control with active sensors (0 - 10 V, 4 - 20 mA). Setting range: 5 - 30 % \pm 5 - 30 % measuring range of sensor. |
| Dipswitch S1 | Basic setting for device function |
| Status LED V13 | Indicate the operating conditions over flashing code |
| Jumper E1 | Basic setting for kind of signal at analog input "E1 = Analog In 1" |

7 Base setup

7.1 Programming of the desired function (Speed controller / P-Controller)

- It is possible to use the device as a “Speed controller” or as a “P-controller”. Selection of the function must first be made by setting the internal jumper “E1” and dipswitch “S1”.
- **Factory setting of internal jumper “E1” in position for 0 - 10 V input signal.** When using other signals bring the jumper in correct position.
- **Factory setting of all dipswitches is **OFF** position for operation as Speed controller **1.01** with external setting signal.** In the following the fundamental dipswitch positions for further modes of operation are represented. Depending upon desired function further adjustments are necessary (☞ function dipswitches).



Attention!

**Setting of jumper and switches not under voltage! Observe the safety notices!
 Changed functions become active partly only after renewed switching on the mains voltage!**

E1 Analog In = (factory setting 0 - 10 V)

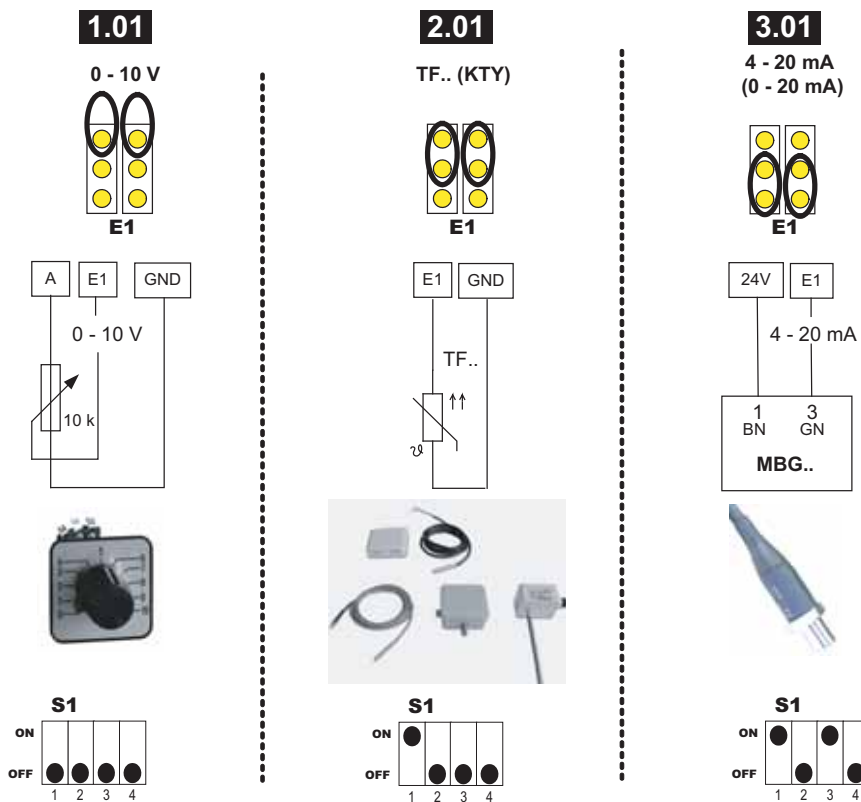

21.07.2008
 v_pke_jumper_e1_dip_s1_mode.vsd

7.2 Select operation mode

Simple installation is possible through the use of modes of operation.

| Mode | Signal or Sensor (input) | Function |
|-------------|--------------------------|--|
| 1.01 | Signal 0 - 10 V | Speed controller, two step operation (factory setting) |
| 2.01 | Sensor TF.. (E1) | Temperature control airconditioning and refrigeration |
| 3.01 | Sensor MBG.. (E1) | Pressure control condensers (refrigeration) |

7.3 Function of dipswitches for operation as Speed controller **1.01** (DIP **1** = **OFF**)

For operation as a speed controller, the output voltage is set manually by adjusting the built-in potentiometer, by an external potentiometer or external signal.

The desired function is determined with dipswitch **S1**.

Position factory setting for all dipswitches = **OFF**

| DIP | Function | OFF | ON |
|-----|---|--|--|
| 1 | Selection: Speed controller / P-Controller | Speed controller | P-Controller |
| 2 | Minimum speed cut off | OFF | ON |
| 3 | Type of Signal | 0 - 10 V, 0 - 20 mA | 2 - 10 V, 4 - 20 mA |
| 4 | Inverting signal input | 0 - 10 V, 2 - 10 V, 0 - 20 mA, 4 - 20 mA | 10 - 0 V, 10 - 2 V, 20 - 0 mA, 20 - 4 mA |

7.4 Function of dipswitches for operation as P-Controller **2.01, 3.01**, (DIP **1** = **ON**)

For operation as a P-controller the actual value measured by the sensor is compared with the nominal value that has been set. The output voltage and hence the rotational speed of the connected motor automatically change as a function of the parameter settings.

The desired function is determined with dipswitch **S1**.

Position factory setting for all dipswitches = **OFF**

| DIP | Function | OFF | ON |
|-----|---|---|---|
| 1 | Selection: Speed controller / P-Controller | Speed controller | P-Controller |
| 2 | Minimum speed cut off | OFF | ON |
| 3 | Type of Signal | 0 - 10 V, 0 - 20 mA TF.. (KTY) | 2 - 10 V, 4 - 20 mA |
| 4 | Control function (e.g. "Cooling" / "Heating") | increasing modulation for increasing actual value | increasing modulation for decreasing actual value |

7.5 Minimum speed cut off DIP 2

7.5.1 For mode Speed controller **1.01**

If no "n-min" is adjusted, output voltage goes continuously with reduction of the regulating variable down to "0" (cutoff below approx. 2 % regulating variable).

Without minimum speed cut OFF (DIP 2 = **OFF) = factory setting)**

- If minimal speed "n-min" is adjusted (e.g. 20%), then no disconnection of the fan takes place. I.e. always a minimum ventilation is ensured (fan does not go under setting "n-min").

With minimum speed cut off (DIP 2 = **ON)**

- Cutoff below approx. 2 % regulating variable from setting "n-min" to "0".
- Switch on again for a regulating variable above 5 % (to setting "n-min").

Functional diagram  setting for operation as Speed controller

7.5.2 For operation as P-Controller **2.01**, **3.01**

Without minimum speed cut OFF (DIP 2 = OFF) = factory setting)

- If no “n-min” is adjusted, the fan stops with reaching the desired value.
- If “n-min” is adjusted (e.g. 20 %), then no disconnection of the fan takes place. I.e. always a minimum ventilation is ensured (fan does not go under setting “n-min”).

With minimum speed cut off (DIP 2 = ON)

- When the setpoint is reached, the modulation is reduced to “0 %”, or to the set value if “n-min” is specified.
- For actual value = setpoint disconnection takes place from “n-min” to “0”. Hysteresis (ON / OFF) approx. 2.5 % of 100 % set value.

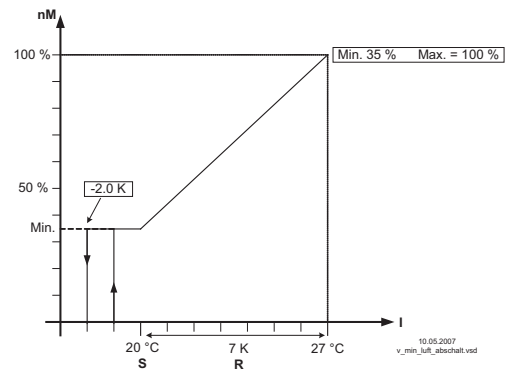

Minimum speed cut off (idealized principle diagram)

nM Motor speed
S Setpoint
R Pband
I Actual value

8 Start-up

8.1 Prerequisites for commissioning



Attention!

1. You must mount and connect the device in accordance with the operating instructions.
2. Check all connections for correctness once more.
3. The mains voltage must match the information on the rating plate.
4. The rated current on the rating plate will not be exceeded.
5. Make sure that no persons or objects are in the fan's hazardous area.

9 Setting for operation

9.1 Speed controller **1.01**

9.1.1 Setting for operation as Speed controller

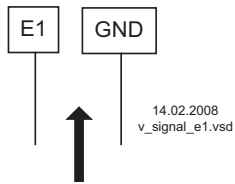
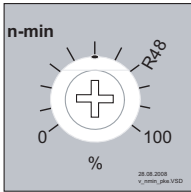
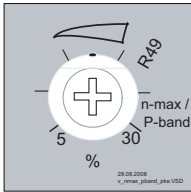
| | |
|--|---|
| <p>Signal to: E1</p>  <p>14.02.2008 v_signal_e1.vsd</p> | <p>E1 Setting via external signal or external potentiometer Setting range: Output voltage from approx. 0 - 100 % of connected line voltage or in range of settings “n-min” up to “n-max”. (Potentiometer set without function)</p> |
|  <p>n-min 0 100 %</p> <p>28.08.2008 v_nmin_pks.VSD</p> | <p>n-min Setting of output voltage at the device 0 - 100 %. For setting via external signal: Minimum output voltage (basic speed) Setting range: 0 - 100 % (“n-min” takes priority if over “n-max”).</p> |
|  <p>n-max / P-band 5 30 %</p> <p>28.08.2008 v_nmax_pband_pks.VSD</p> | <p>n-max / Pband Maximal output voltage (speed limiter) Setting range: 100 % - “n-min” (100 % output voltage = fully clockwise position 30 %)</p> |

9.1.2 Diagram: setting signal and speed

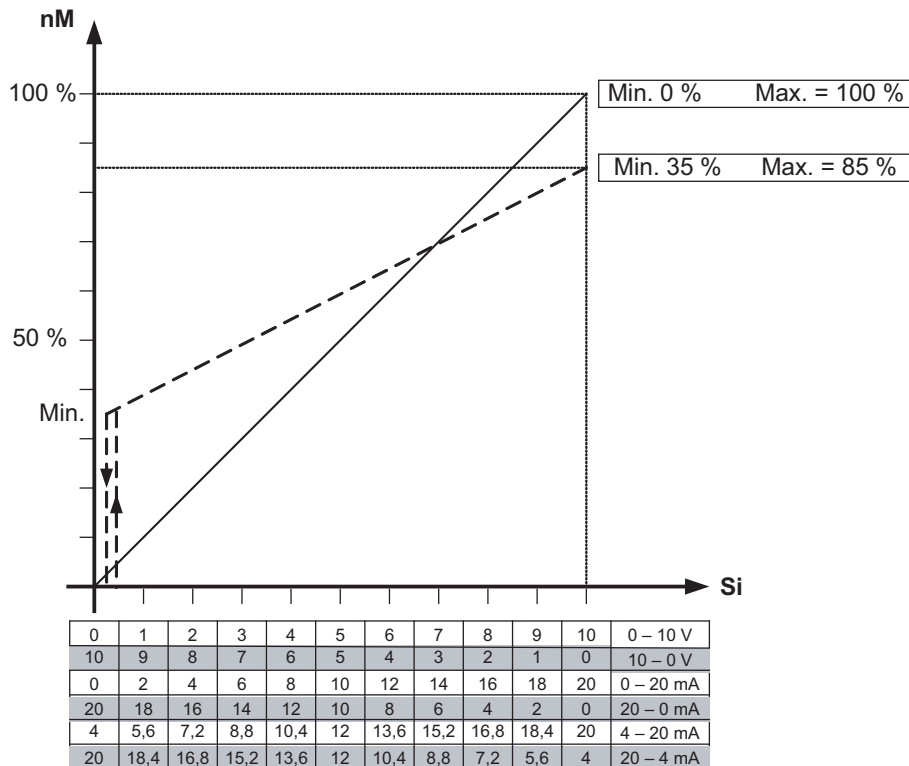

05.02.2008
v_nmotor_101_miluab.vsd

Idealized principle diagram

nM Motor speed
Si Signal

9.1.3 Operation with two variable output voltages (two steps)

Switchover between two steps via external potential-free contact possible.

- **Step 1** (low speed). When there is no input signal connected to the input terminal “E1”, then the unit supplies the output voltage set by “n-min”.
- **Step 2** (high speed). When the terminal “ A1” (+10 V) is connected with the input terminal “E1” then the units supplies the output voltage set by “n-max”.

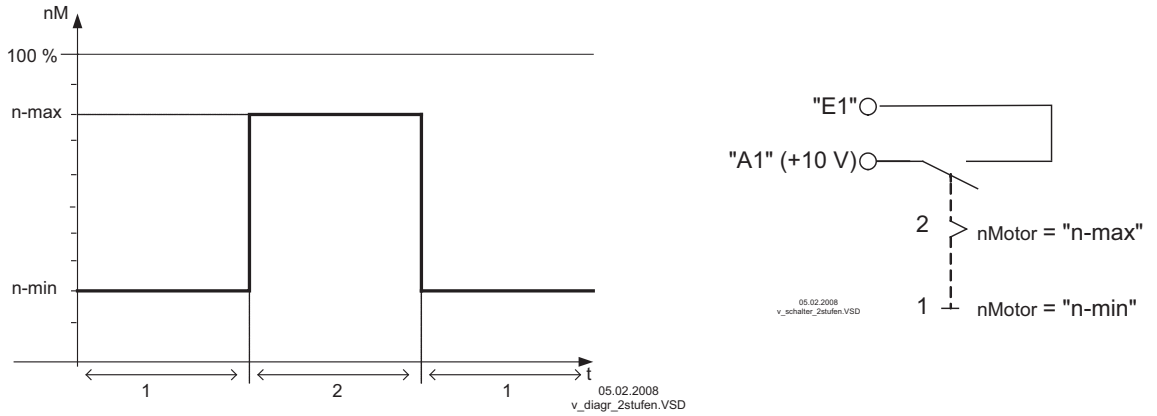

9.2 Temperature control (P-Controller) 2.01

9.2.1 Setting for operation as Temperature controller

| | |
|--|---|
| | <p>set For control with active sensors (0 - 10 V, 4 - 20 mA) Setting range: 0 - 100 % \pm measuring range of sensor</p> <p>For Temperature control with passive sensors TF.. (KTY) Setting range: 0 - 100 % \pm -26...76 °C (measuring range of controller)</p> |
|--|---|

Scale 0 - 100 % \pm -26...76 °C for Temperature control with passive sensors TF.. (KTY)

| set [%] | 0 | 5 | 10 | 15 | 20 | 25 | 30 | 35 | 40 | 45 | 50 | 55 | 60 | 65 | 70 | 75 | 80 | 85 | 90 | 95 | 100 |
|---------|-------|-------|-------|-------|------|------|-----|-----|------|------|------|------|------|------|------|------|------|------|------|------|------|
| [° C] | -26.0 | -20.9 | -15.8 | -10.7 | -5.6 | -0.5 | 4.6 | 9.7 | 14.8 | 19.9 | 25.0 | 30.1 | 35.2 | 40.3 | 45.4 | 50.5 | 55.6 | 60.7 | 65.8 | 70.9 | 76.0 |

| | |
|--|---|
| | <p>n-max= Pband small control range = short control times big control range = longer control times and (higher controller stability)</p> <p>For control with active sensors (0 - 10 V, 4 - 20 mA) Setting range: 0 - 100 % \pm 5 - 30 % measuring range of sensor</p> <p>For Temperature control with passive sensors TF.. (KTY) Setting range: 0 - 100 % \pm 5.1 - 30.6 K</p> |
| | <p>n-min Minimum output voltage (basic speed) Setting range: 0 - 100 % (“n-min” takes priority if over “n-max”)</p> |

9.2.2 Example Temperature control “Cooling function” (factory setting)

- “Val > Set = n+” (DIP4 = **OFF**)
- Temperature sensor type TF..
- Measuring range controller -26...+76 °C

Settings:

- **set** = 50 % \pm 25 °C (102 K / 100 % x 50 % - 26 °C)
- **Pband** = 10 % \pm 10.2 K (102 K / 10)

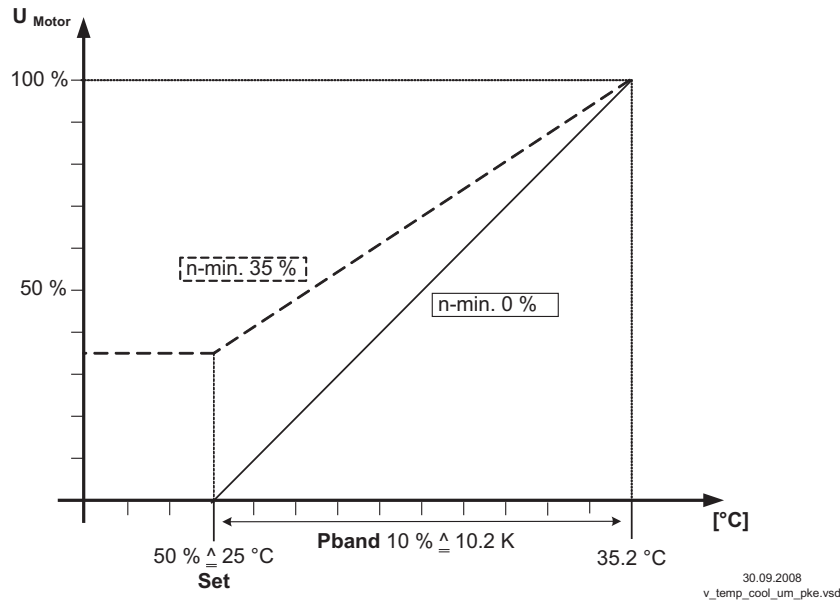

Idealized principle diagram

9.2.3 Example Temperature control “Heating function”

- “Val < Set = n+” (DIP4 = **ON**)
- Temperature sensor type TF..
- Measuring range controller -26...+76 °C

Settings:

- **set** = 50 % \pm 25 °C (102 K / 100 % x 50 % - 26 °C)
- **Pband** = 10 % \pm 10.2 K (102 K / 10)

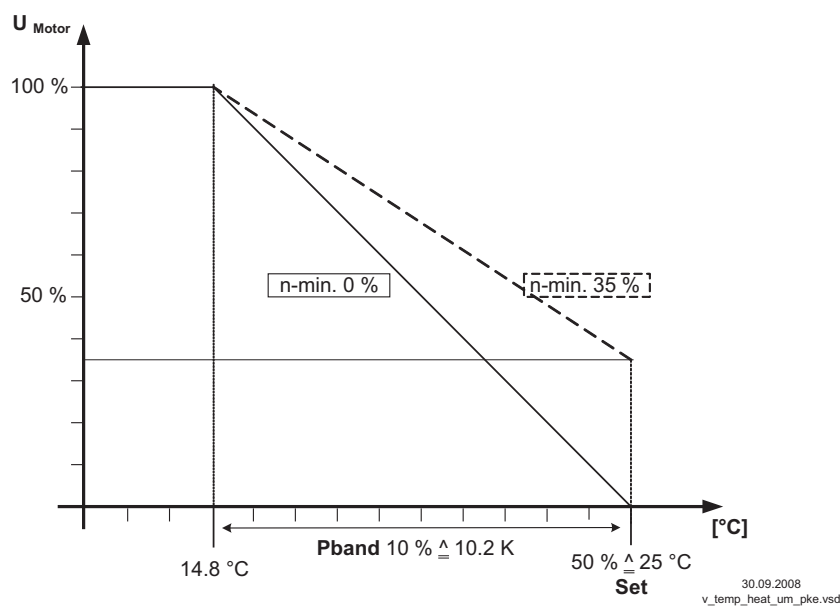

Idealized principle diagram

9.3 Pressure control condensers (P-Controller) **3.01**

9.3.1 Setting for operation as Pressure controller

| | |
|--|--|
| | <p>set For control with active sensors (0 - 10 V, 4 - 20 mA) Setting range: 0 - 100 % \pm measuring range of sensor</p> |
| | <p>n-max/ Pband small control range = short control times big control range = longer control times and (higher controller stability)</p> <p>For control with active sensors (0 - 10 V, 4 - 20 mA) Setting range: 0 - 100 % \pm 5 - 30 % measuring range of sensor</p> |
| | <p>n-min Minimum output voltage (basic speed) Setting range: 0 - 100 % ("n-min" takes priority if over "n-max")</p> |

9.3.2 Example Pressure control condensers

Pressure sensor

- Type MBG-30I
- Measuring range 0 - 30 bar
- Output signal 4...20 mA

Settings:

- **set** = 50 % \pm 15.0 bar, in use of refrigerant medium table for R507
- **Pband** = 10 % \pm 3.0 bar

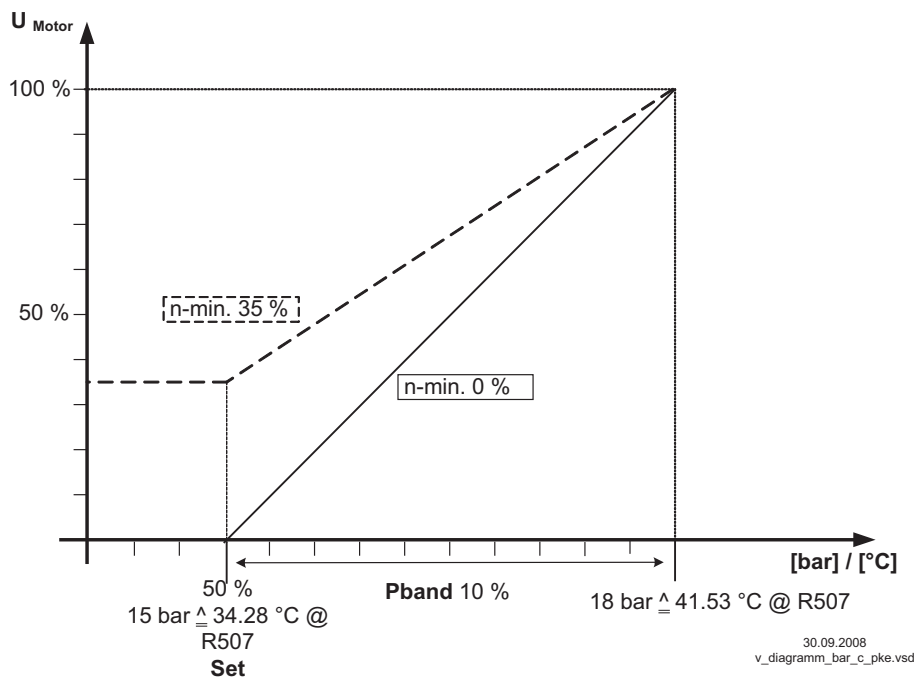

Idealized principle diagram

9.3.3 Setting with refrigerant medium table



Information

Calculation for relative pressure (differential measurement of pressure relative to ambient pressure).

| Set | 0 % | 5 % | 10 % | 15 % | 20 % | 25 % | 30 % | 35 % | 40 % | 45 % | 50 % | 55 % | 60 % | 65 % | 70 % | 75 % | 80 % | 85 % | 90 % | 95 % | 100 % |
|---------------|--------|--------|--------|--------|--------|--------|--------|--------|--------|--------|--------|--------|--------|--------|--------|--------|--------|----------|--------|--------|--------|
| MBG-30l [bar] | 0.00 | 1.50 | 3.00 | 4.50 | 6.00 | 7.50 | 9.00 | 10.50 | 12.00 | 13.50 | 15.00 | 16.50 | 18.00 | 19.50 | 21.00 | 22.50 | 24.00 | 25.50 | 27.00 | 28.50 | 30.00 |
| I [mA] | 4.0 | 4.8 | 5.6 | 6.4 | 7.2 | 8.0 | 8.8 | 9.6 | 10.4 | 11.2 | 12.0 | 12.8 | 13.6 | 14.4 | 15.2 | 16.0 | 16.8 | 17.6 | 18.4 | 19.2 | 20.0 |
| R12 [°C] | -30.09 | -6.28 | 8.11 | 18.90 | 27.70 | 35.22 | 41.84 | 47.80 | 53.23 | 58.23 | 62.90 | 67.27 | 71.39 | 75.30 | 79.01 | 82.57 | 85.97 | 89.24 | 92.39 | 95.43 | 98.37 |
| R13 [°C] | -81.99 | -62.83 | -51.33 | -42.75 | -35.77 | -29.82 | -24.60 | -19.91 | -15.65 | -11.72 | -8.07 | -4.65 | -1.43 | 1.61 | 4.51 | 7.27 | 9.91 | 12.45 | 14.89 | 17.25 | 19.52 |
| R13b1 [°C] | -58.14 | -36.81 | -23.92 | -14.26 | -6.38 | 0.36 | 6.29 | 11.63 | 16.49 | 20.97 | 25.15 | 29.06 | 32.75 | 36.25 | 39.58 | 42.76 | 45.81 | 48.74 | 51.56 | 54.28 | 56.92 |
| R22 [°C] | -41.11 | -19.52 | -6.57 | 3.09 | 10.95 | 17.65 | 23.53 | 28.80 | 33.60 | 38.02 | 42.13 | 45.97 | 49.59 | 53.02 | 56.27 | 59.38 | 62.35 | 65.20 | 67.95 | 70.59 | 73.15 |
| R23 [°C] | -82.44 | -64.82 | -54.36 | -46.61 | -40.34 | -35.02 | -30.36 | -26.20 | -22.43 | -18.96 | -15.75 | -12.75 | -9.94 | -7.27 | -4.75 | -2.35 | -0.05 | 2.15 | 4.26 | 6.30 | 8.26 |
| R32 [°C] | -52.53 | -32.24 | -20.30 | -11.51 | -4.44 | 1.54 | 6.76 | 11.41 | 15.62 | 19.47 | 23.03 | 26.35 | 29.47 | 32.40 | 35.18 | 37.83 | 40.35 | 42.76 | 45.07 | 47.30 | 49.44 |
| R114 [°C] | 3.45 | 30.02 | 46.05 | 58.04 | 67.82 | 76.17 | 83.53 | 90.13 | 96.15 | 101.70 | 106.87 | 111.71 | 116.27 | 120.59 | 124.71 | 128.63 | 132.40 | 136.0-11 | 139.49 | 142.85 | 146.10 |
| R134a [°C] | -26.43 | -4.29 | 8.93 | 18.75 | 26.72 | 33.49 | 39.43 | 44.75 | 49.58 | 54.02 | 58.14 | 61.99 | 65.62 | 69.04 | 72.30 | 75.40 | 78.36 | 81.20 | 83.93 | 86.57 | 89.11 |
| R142B [°C] | -10.07 | 15.44 | 30.54 | 41.71 | 50.72 | 58.37 | 65.05 | 71.01 | 76.42 | 81.38 | 85.98 | 90.27 | 94.29 | 98.09 | 101.70 | 105.13 | 108.40 | 111.54 | 114.55 | 117.44 | 120.24 |
| R227 [°C] | -17.58 | 5.82 | 20.05 | 30.76 | 39.52 | 47.03 | 53.66 | 59.63 | 65.09 | 70.13 | 74.83 | 79.24 | 83.41 | 87.37 | 91.13 | 94.74 | 98.20 | 101.52 | 104.73 | 107.83 | 110.83 |
| R401 [°C] | -27.05 | -4.65 | 8.71 | 18.63 | 26.68 | 33.52 | 39.52 | 44.89 | 49.77 | 54.25 | 58.41 | 62.30 | 65.96 | 69.41 | 72.70 | 75.82 | 78.81 | 81.68 | 84.44 | 87.09 | 89.66 |
| R401A [°C] | -29.21 | -6.93 | 6.40 | 16.33 | 24.39 | 31.26 | 37.28 | 42.68 | 47.59 | 52.10 | 56.29 | 60.22 | 63.91 | 67.40 | 70.72 | 73.88 | 76.91 | 79.81 | 82.60 | 85.29 | 87.99 |
| R401B [°C] | -28.97 | -6.74 | 6.52 | 16.37 | 24.35 | 31.14 | 37.08 | 42.41 | 47.24 | 51.69 | 55.81 | 59.67 | 63.29 | 66.72 | 69.97 | 73.07 | 76.03 | 78.87 | 81.60 | 84.23 | 86.77 |
| R402 [°C] | -47.59 | -26.34 | -13.71 | -4.36 | 3.21 | 9.64 | 15.26 | 20.29 | 24.85 | 29.04 | 32.92 | 36.55 | 39.95 | 43.17 | 46.23 | 49.13 | 51.91 | 54.57 | 57.13 | 59.59 | 61.97 |
| R402A [°C] | -47.59 | -26.34 | -13.71 | -4.36 | 3.21 | 9.64 | 15.26 | 20.29 | 24.85 | 29.04 | 32.92 | 36.55 | 39.95 | 43.17 | 46.23 | 49.13 | 51.91 | 54.57 | 57.13 | 59.59 | 61.97 |
| R402B [°C] | -45.46 | -24.06 | -11.33 | -1.89 | 5.75 | 12.23 | 17.92 | 22.99 | 27.61 | 31.84 | 35.77 | 39.44 | 42.89 | 46.14 | 49.23 | 52.18 | 54.99 | 57.69 | 60.28 | 62.77 | 65.18 |
| R404A [°C] | -46.36 | -24.92 | -12.18 | -2.74 | 4.89 | 11.37 | 17.04 | 22.11 | 26.72 | 30.94 | 34.86 | 38.52 | 41.95 | 45.20 | 48.28 | 51.21 | 54.01 | 56.70 | 59.28 | 61.67 | 64.16 |
| R407A [°C] | -39.47 | -18.64 | -6.32 | 2.78 | 10.13 | 16.36 | 21.80 | 26.66 | 31.06 | 35.10 | 38.84 | 42.33 | 45.60 | 48.69 | 51.62 | 54.41 | 57.07 | 59.62 | 62.06 | 64.42 | 66.69 |
| R407B [°C] | -43.49 | -22.74 | -10.44 | -1.34 | 6.01 | 12.24 | 17.69 | 22.55 | 26.97 | 31.02 | 34.77 | 38.27 | 41.56 | 44.66 | 47.61 | 50.41 | 53.09 | 55.65 | 58.11 | 60.48 | 62.76 |
| R407C [°C] | -37.31 | -16.35 | -3.95 | 5.22 | 12.62 | 18.89 | 24.37 | 29.27 | 33.70 | 37.77 | 41.54 | 45.06 | 48.36 | 51.47 | 54.43 | 57.24 | 59.92 | 62.49 | 64.96 | 67.34 | 69.63 |
| R500 [°C] | -33.80 | -10.77 | 3.02 | 13.28 | 21.62 | 28.72 | 34.96 | 40.54 | 45.62 | 50.29 | 54.63 | 58.69 | 62.51 | 66.13 | 69.56 | 72.83 | 75.97 | 78.97 | 81.86 | 84.65 | 87.34 |
| R502 [°C] | -45.54 | -23.63 | -10.53 | -0.77 | 7.15 | 13.89 | 19.81 | 25.10 | 29.92 | 34.35 | 38.47 | 42.32 | 45.94 | 49.37 | 52.62 | 55.72 | 58.69 | 61.54 | 64.28 | 66.91 | 69.46 |
| R503 [°C] | -88.64 | -70.55 | -59.77 | -51.77 | -45.29 | -39.79 | -34.96 | -30.65 | -26.73 | -23.12 | -19.78 | -16.66 | -13.72 | -10.95 | -8.32 | -5.81 | -3.41 | -1.11 | 1.10 | 3.22 | 5.28 |
| R507 [°C] | -46.51 | -25.59 | -13.02 | -3.64 | 3.98 | 10.49 | 16.20 | 21.32 | 25.99 | 30.28 | 34.28 | 38.01 | 41.53 | 44.86 | 48.03 | 51.05 | 53.94 | 56.72 | 59.39 | 61.97 | 64.46 |
| R717 [°C] | -33.59 | -13.65 | -1.88 | 6.80 | 13.80 | 19.73 | 24.91 | 29.52 | 33.71 | 37.54 | 41.09 | 44.40 | 47.50 | 50.43 | 53.21 | 55.84 | 58.36 | 60.78 | 63.09 | 65.32 | 67.46 |

10 Diagnostics / Faults

Operating conditions are indicated by the internal status LED **V13** with flashing code.

| Code | Explanation | Reaction of Controller |
|------------|--|---|
| V13 | | Adjustment |
| OFF | no line voltage | In the event of a mains interruption the unit switches "OFF" and automatically "ON" when the voltage has been restored. Check line and internal controller fuse. |
| ON | Normal operation without fault | |
| 1 | no enable Terminlas "D1" - "GND" (Digital In 1) not bridged. | Switch OFF by external contact (⚡ digital input). |
| 2 | Signal fault Function only for operation as P-Controller, PI-Controller (2.01)! Interruption or short circuit in the sensor leads or sensor values measured are outside measuring range: - For temperature sensors TF.. (KTY) below approx. - 26 °C and above approx. 76 °C - For active sensors with reaching minimum or maximum signal values (depending on selected signal type). | The device works with minimal or maximum modulation depending on whether there is a short-circuit or an interruption, and on the programmed mode of operation. The controller functions automatically again with the value measured at the temperature sensor after the fault has been rectified. Check sensor. |



28.08.2008
v_flash_code_pxe.VSD

10.1 If controller doesn't work correctly



Information

Setting of dip switches in principle only when device is not under voltage!
If the device is on mains supply modifications will partly not be identified and realized.



Attention!

It is forbidden to carry out work on electrically live parts. The enclosure rating of the device when open is IP 00! It is possible to inadvertently touch components carrying hazardous voltages!

11 Enclosure

11.1 Technical data

| Type | Part.-No. | Rated current {1} | Max. line fuse {2} | semiconductor fuse {3} | Max. heat dissipation approx. {1} | Weight |
|--------|-----------|----------------------|-----------------------|---|--------------------------------------|--------|
| | | [A] | [A] | [Part.-No.] | [W] | [kg] |
| PKE-6 | 303614 | 6 | 10 | FF20 A 6x32 mm (pack of 10 fuses: 349026) | 15 W | 0.6 |
| PKE-10 | 303615 | 10 | 16 | FF20 A 6x32 mm (pack of 10 fuses: 349026) | 25 W | 0,8 |
| PKE-14 | 303625 | 14 | 20 | FF25 A | 35 W | 2.0 |

{1} with supply voltage of 230 V / 50 Hz, values for other specifications available on request

{2} Max. supply side line fuse according to DIN EN 60204-1 classification VDE0113 chapter 1

{3} Semiconductor fuse not in the scope of supply, as accessories available. For protection of damages in the case of short-circuits installation on site recommended.

| | |
|---|--|
| Line voltage | 1 ~ 230 V (-15...+10 %), 50/60 Hz |
| Input resistance for sensor or signal set for the rotational speed | for 0 - 10 V input: $R_i > 100 \text{ k}\Omega$ for 4 - 20 mA input: $R_i = 100 \Omega$ |
| output voltage | approx. 0 - 100 % of applied mains voltage |
| Min. motor current | approx. 0.2 A |
| Voltage supply e.g. for sensors | +24 V $\pm 20 \%$, $I_{\text{max}} 20 \text{ mA}$ |
| Output (10 V) | $I_{\text{max}} 10 \text{ mA}$ (short-circuit-proof) |
| Max. permissible ambient temperature | 40 °C |
| Min. permissible ambient temperature | 0 °C (if mains voltage is not switched off up to -20 °C) |
| Max. permissible installation height | 0...4000 m amsl Above 1000 m amsl the rated current is to be reduced by 5 % / 1000 m. |
| Permissible rel. humidity | 85 % no condensation |
| Electromagnetic compatibility for the standard voltage 230 / 400 V according to DIN IEC 60038 | Interference emission EN 61000-6-3 (domestic household applications) |
| | Interference immunity EN 61000-6-2 (industrial applications) |
| Harmonics current according | In accordance with EN 61000-3-2 Up to a maximum current of 4 A, the limits are adhered to with no restrictions. |
| Housing protection | IP54 |

11.1.1 Performance reduction during elevated ambient temperatures

The maximum permissible ambient temperature for the devices is 40 °C. Up to this temperature, loading (maximum continuous current) with the specified rated current is possible.

The removal of heat in the unit due to power dissipation is dependent on the ambient temperature, so the maximum load has to be reduced if the ambient temperature is higher than 40 °C! For each degree higher the load has to be reduced approx. 2.2 %. The average value measured during a 24 h period must be 5 K under the max. ambient temperature. For installation in a switch cabinet, the device's dissipation and its possible affect on the ambient temperature must be taken into consideration (Technical data)!

Maximum load for ambient temperatures higher 40 °C

| Type | Part.-No. | Rated current for 40 °C | max. current load for 50 °C | max. current load for 55 °C |
|--------|-----------|-------------------------|-----------------------------|-----------------------------|
| | | [A] | [A] | [A] |
| PKE-6 | 303614 | 6 | 4.5 | 4.0 |
| PKE-10 | 303615 | 10 | 7.0 | 6.0 |
| PKE-14 | 303625 | 14 | 12.0 | 10.0 |

11.2 Connection diagram

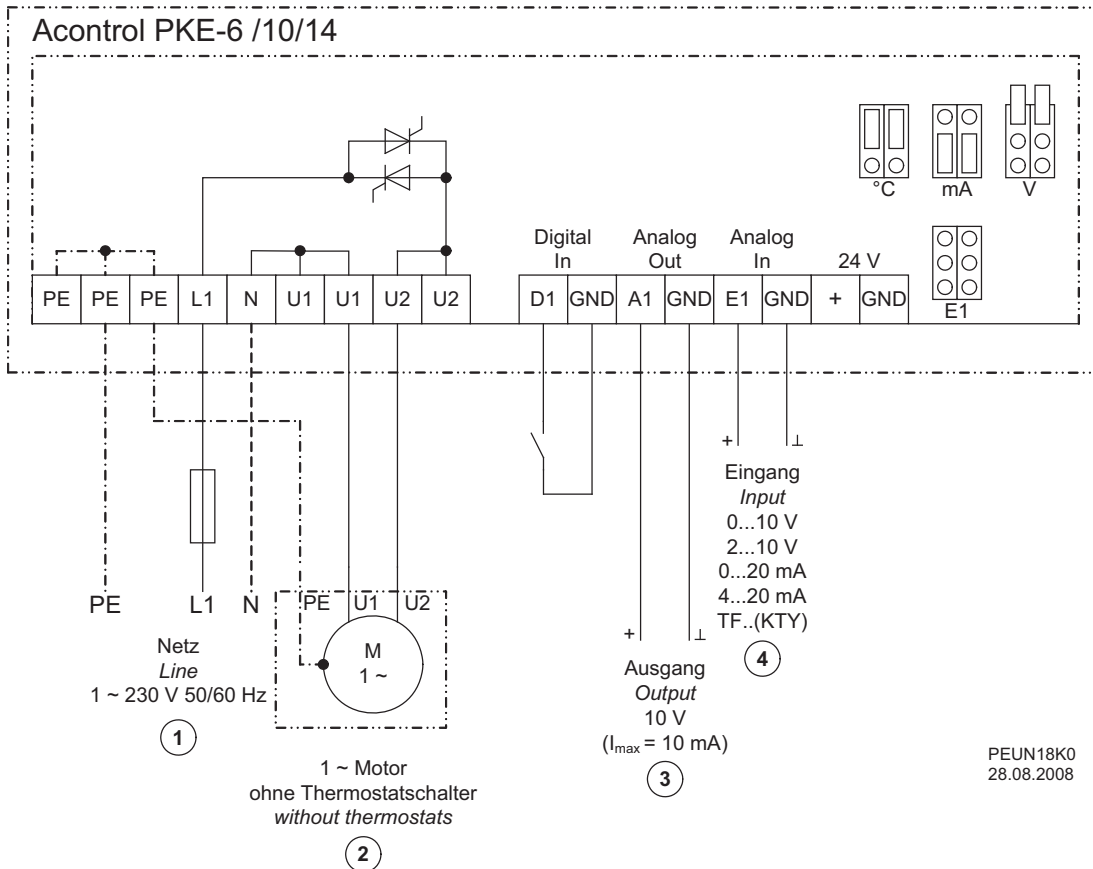

- 1 Line 1 ~ 230 V, 50/60 Hz
- 2 1 ~ Motor without thermostats
- 3 Output 0...10 V ($I_{max} = 10 \text{ mA}$)
- 4 Input: 0...10 V, 2...10 V, 0...20 mA, 4...20 mA, TF..(KTY)

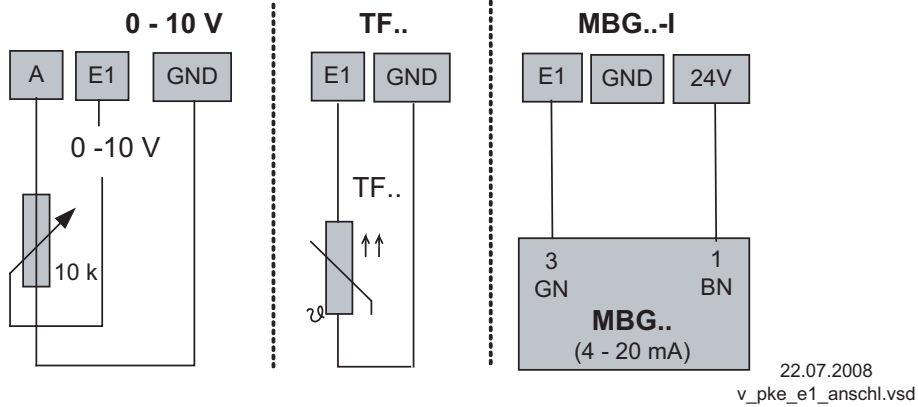

11.2.1 Connection diagram motor protection unit for motors with thermostats type S-ET10

- Full motor protection by switch-off when activating the attached thermostat switches. Reset after malfunction by key press.
- No cut-off if the mains supply is interrupted

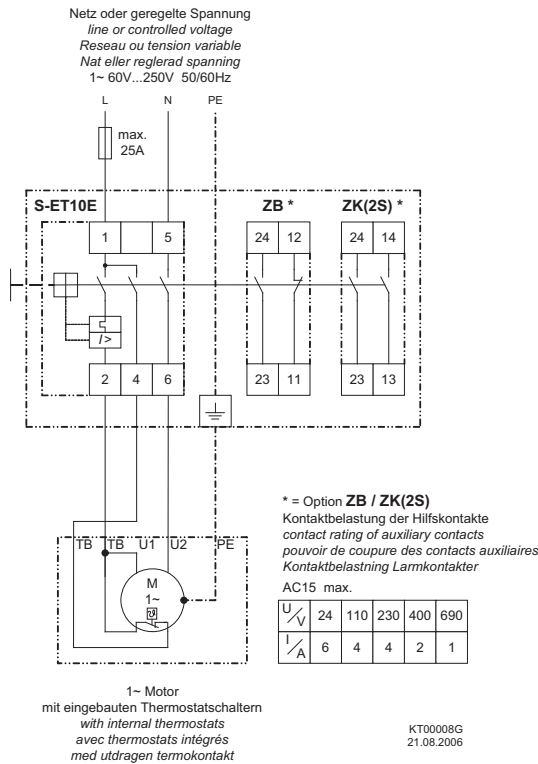

11.3 Dimensions [mm]

PKE-6, PKE-10

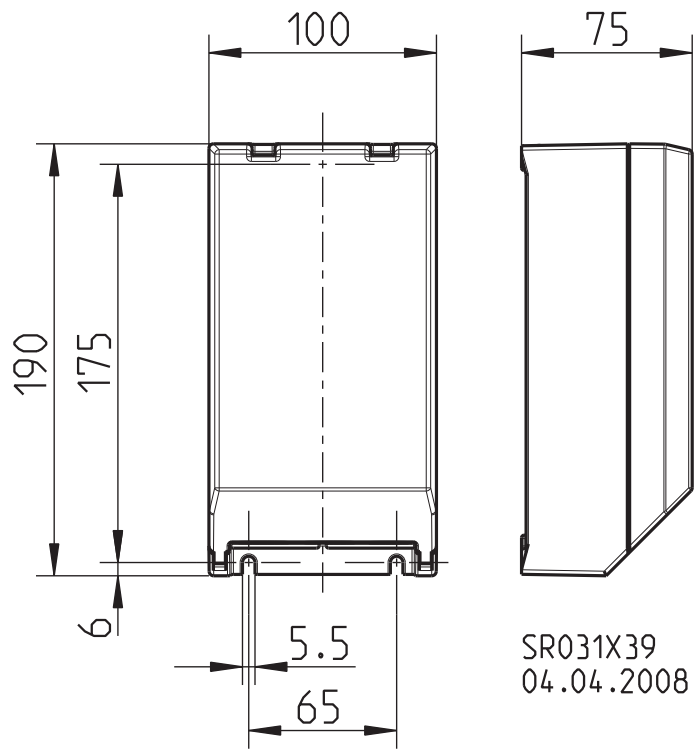

PKE-14

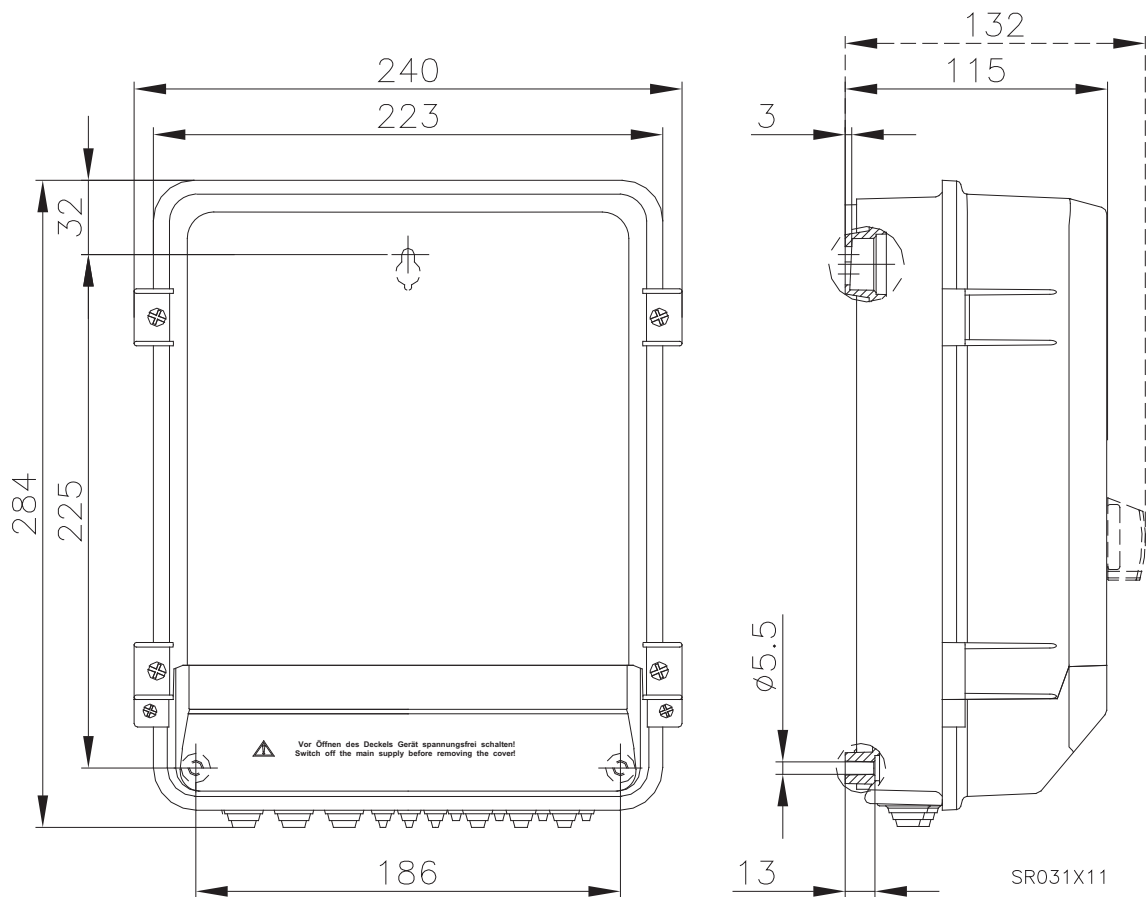

11.4 Index

| | |
|---------------------------|-------|
| B | |
| basic speed | 11 |
| C | |
| control cable | 8 |
| E | |
| external potentiometer | 15 |
| external signal | 15 |
| H | |
| heat dissipation | 21 |
| I | |
| Input resistance | 21 |
| L | |
| line fuse | 21 |
| M | |
| mains is connected | 8 |
| mains voltage | 8 |
| maximum control current | 9 |
| MBG-30I | 18 |
| Minimum space requirement | 7 |
| Minimum speed cut off | 14 |
| Mode | 12 |
| motor feed cable | 8 |
| motor noise | 9 |
| motor protection unit | 9 |
| O | |
| Outdoor installation | 7 |
| P | |
| P-Controller | 12 |
| Phase cutting | 9 |
| R | |
| refrigerant medium table | 19 |
| relative pressure | 19 |
| S | |
| Speed controller | 12 |
| speed limiter | 11 |
| standard voltages | 8 |
| T | |
| Technical data | 2, 21 |
| two steps | 16 |
| two-wire-technology | 9 |

11.5 **Manufacturer reference**

Our products are manufactured in accordance with the relevant international regulations. If you have any questions concerning the use of our products or plan special uses, please contact:

Ziehl-Abegg AG
Heinz-Ziehl-Straße
74653 Künzelsau
Telephone: +49 (0) 7940 16-0
Telefax: +49 (0) 7940 16-504
info@ziehl-abegg.de
http://www.ziehl-abegg.de

11.6 **Service information**

If you have any technical questions while commissioning or regarding malfunctions, please contact our V-STE support department for control systems - ventilation technology.

Our worldwide contacts are available in our subsidiaries for deliveries outside of Germany. 
www.ziehl-abegg.com.

If you make returns for inspections or repairs we need certain information in order to facilitate focused trouble shooting and fast repair. Please use our repair tickets for this. It is provided to you after you have consulted our support department.

In addition, you can download it from our homepage. Download - Ventilation Technology - Topic: Control Engineering - Document type: General documents.